

TC-979-IP
 Rev A, Feb 2017
 www.commscope.com

Gels seal for the oval cable port of FIST-GCO2-BX6/BX8 and FX6

Content

1 General product information

2 Kit content

3 Installation

- 3.1 General
- 3.2 Cable fixation in the FIST-GCO2-BX6
- 3.3 Cable fixation in the FIST-GCO2-FX
- 3.4 Cable fixation in the FIST-GCO2-BX8

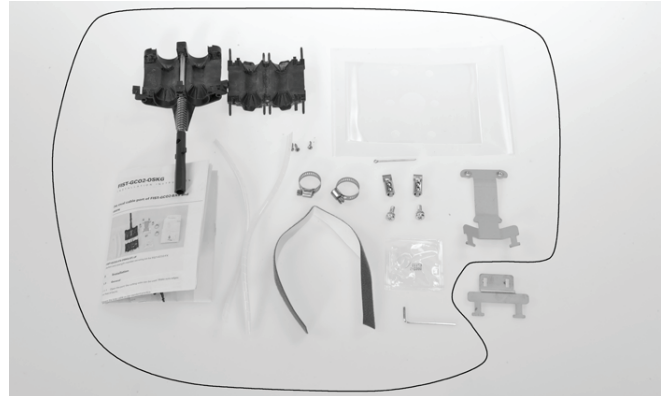

FIST-OSKG

Jacket and strength member securing kit for FIST-GCO2-BX8 and FX6

1 General product information

This kit is used to install a looped cable of 5-18 mm in a new unused oval port of the FIST-GCO2-BX6/BX8 and FX6.

2 Kit content



FIST-GCO2-OSKG-NS

- Gel seal (2 parts)
- Securing screws: 4
- Lubricant
- Spiral tube: 2
- Installation Instruction

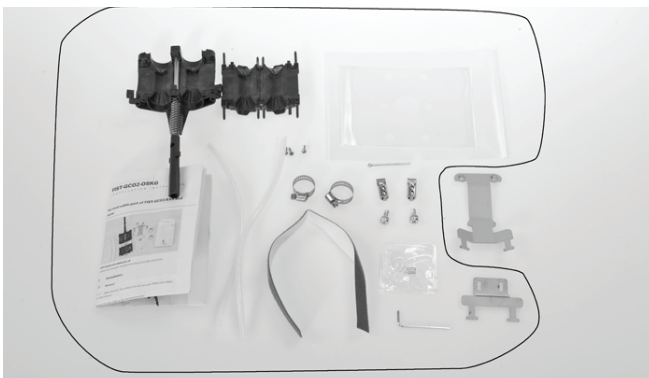

FIST-OSKG

Jacket and strength member securing kit for FIST-GCO2-BX6

3 Installation

3.1 General

Thermoplastic gel seals	
Number of ports	Cable range (mm)
1	11-14
2	8-11
3	6,5-8
4	4-7
8	3-5
16	0-3
FOSC-OSKG	6-15
FIST-OSKG	5-18
FIST-OSKG20	16-20

3.1.1 Open the port; the cutting wire can be used. Make sure edges are free of burrs.

Prepare the loop cable as per standard practice.

3.2 Cable fixation in the FIST-GCO2-BX6

Remark: When uncut fibers will be stored, the window cut needs to be extended with 500 mm.

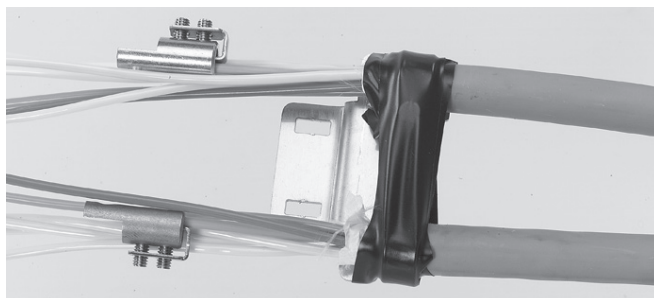
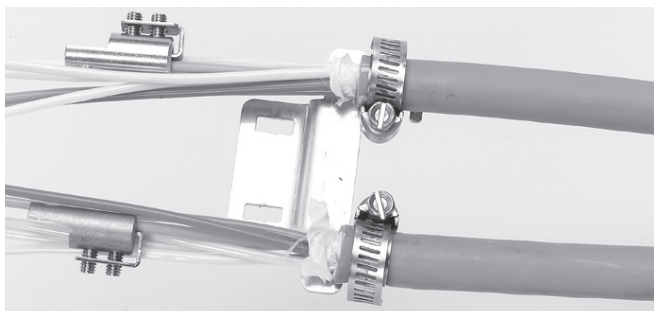

3.2.1 Install the metal bracket as shown: cables on top of metal bracket, hose clamps at the end of the cable jacket. Knobs between the cables. Apply some tape over the hose clamps. Strength members to be cut at 55 mm from the cable jacket.

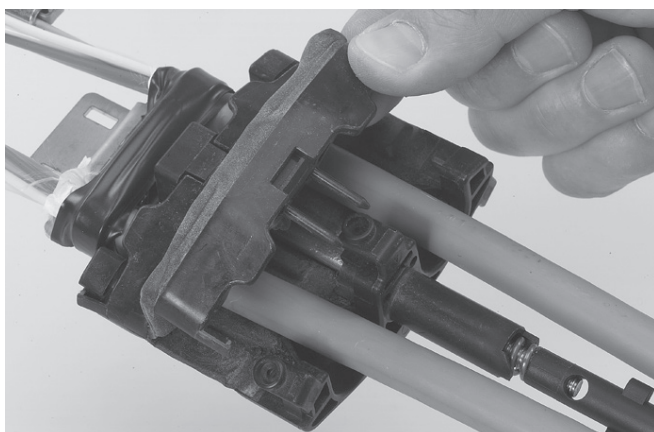
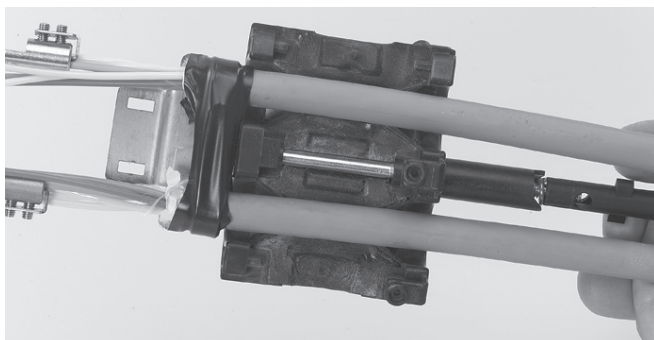

3.2.2 Take the first gel-part (with trigger) and put the 2 cables in place, if needed lubricate the cables. Take 2nd part and insert the pins in the corresponding holes at top and bottom.

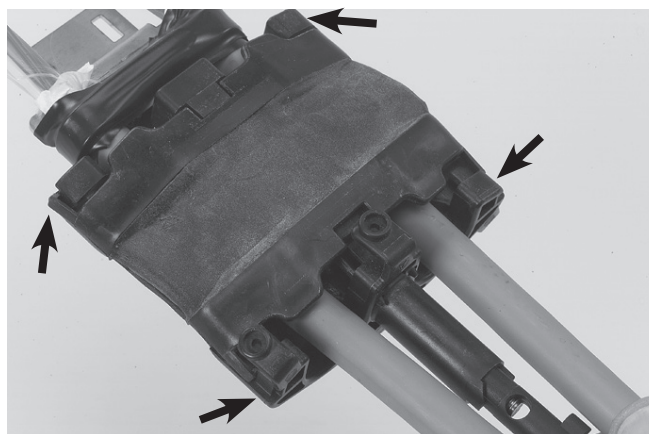

3.2.3 Securing hooks of part 2 must grip in part 1 (2 at top and 2 at bottom).

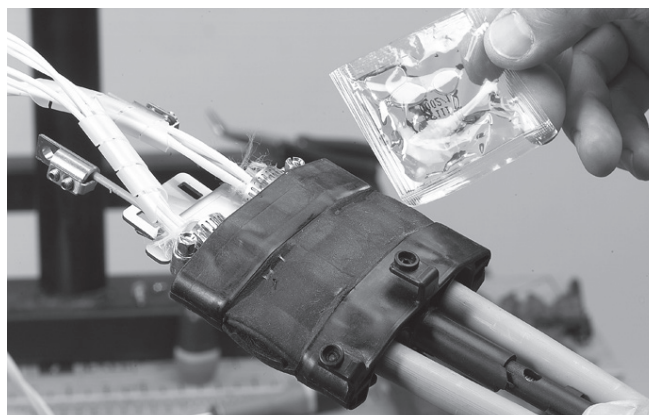

3.2.4 When needed apply some lubricant to the gel for ease of inserting.

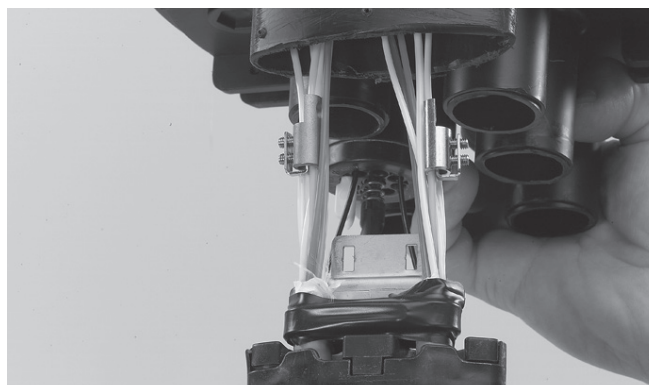

3.2.5 Insert the assembly as shown, metal bracket at the back of the cables!

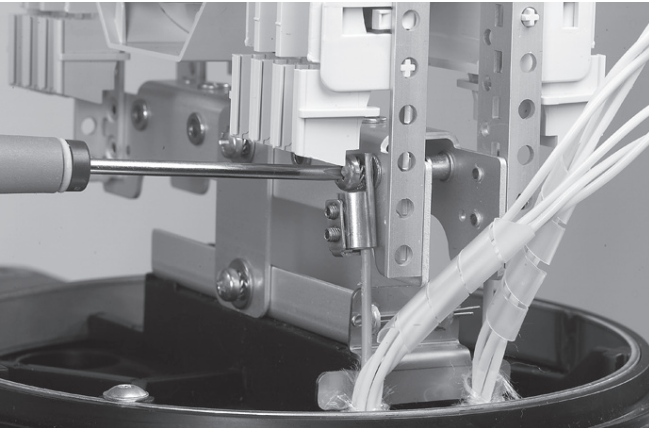
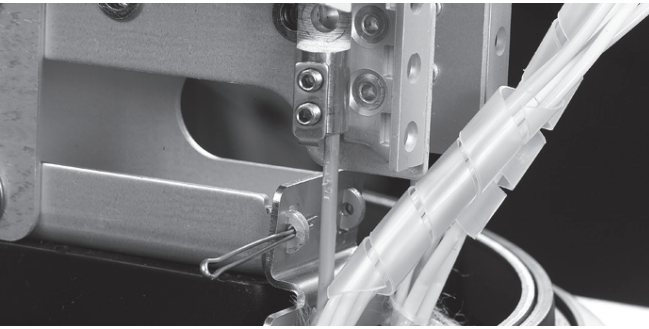

3.2.6 Install the metal bracket to the frame and secure with split pin. Secure the strength members. Install the spiral tube over the loose tubes.



3.2.7 Tighten the 4 screws, make sure they grip in the port.



3.2.8 Tighten the trigger till it butts up with the flange.

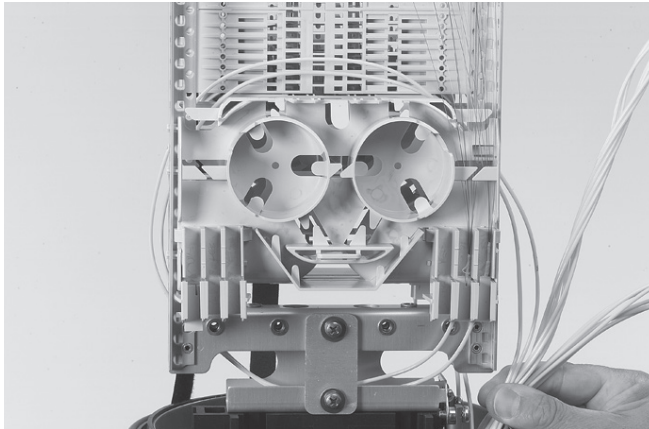
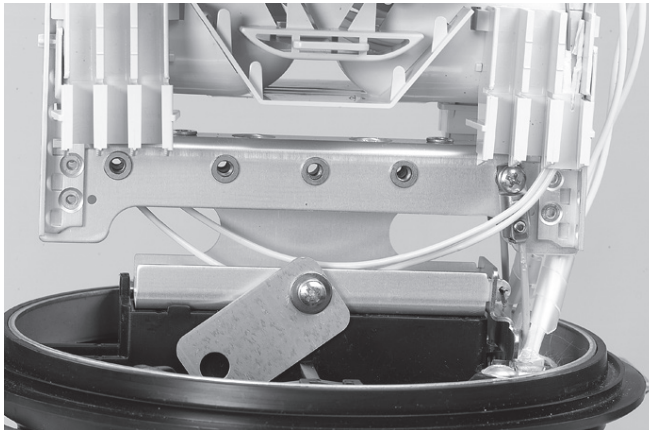

3.2.9 Tubes that will be shaved shall be routed between the UMS profiles (making a circle) and then routed via the bottom frame (release metal fixation plate) to the tube holder. Both sides can be reached. Shave between the 2 marks with the appropriate tooling. Add some PTFE tape to the end of the loose tube and fibers! Proceed as per standard practice.

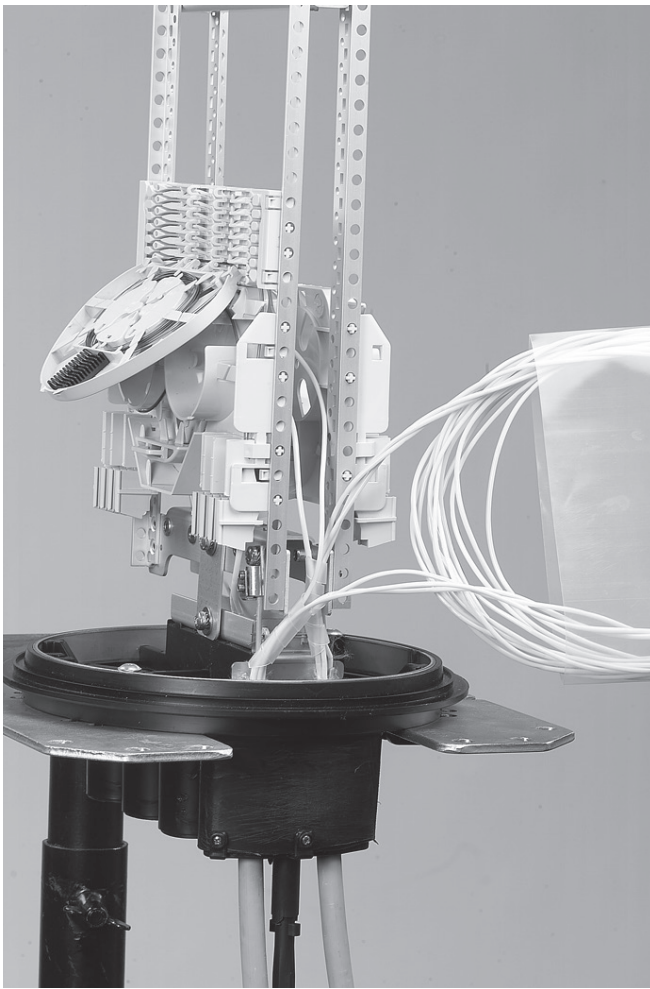

A Optional: FIST-GCO2-BX6-EXT/CF

GCO2-BX cable securing frame

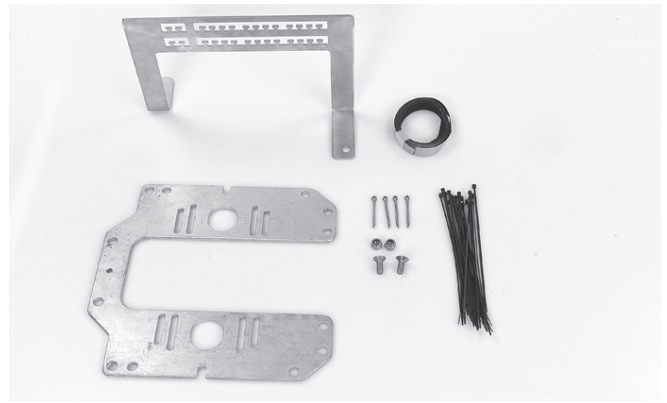

A1 A cable securing frame can be mounted on to the mobra (bolt and nut). This allows cables to be secured outside the closure.

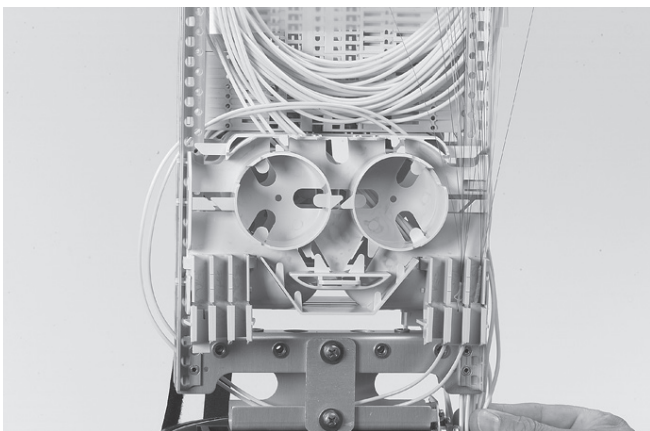

3.2.10 Uncut or unshaved tubes shall be treated as standard practice (store in plastic bag between UMS profiles). Make sure that that the stored loops do not interfere with the shaved tubes.



A2 Apply some foam to the cable(s) and secure with tie-wrap(s) to the frame.

3.3 Cable fixation in the FIST-GCO2-FX

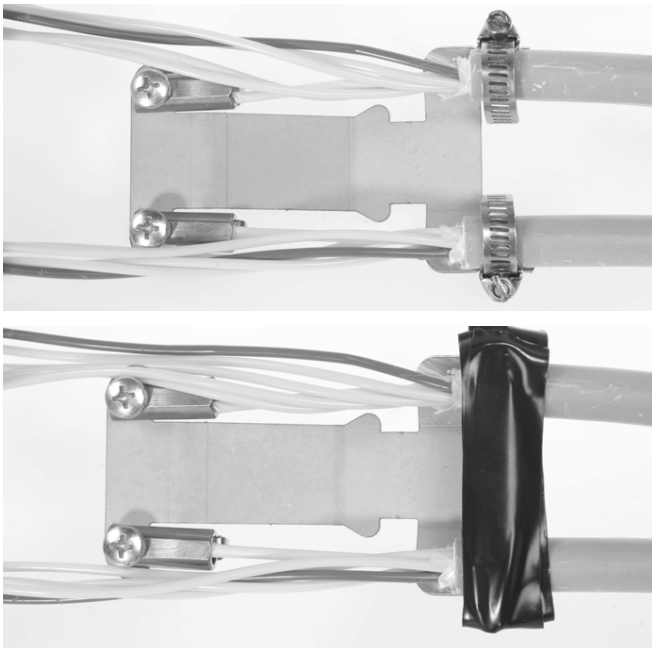

3.3.1 Install the metal bracket as shown, hose clamps at the end of the cable jacket. Knobs between the cables. Apply some tape over the hose clamps. Strength members to be cut at 60 mm from the cable jacket.

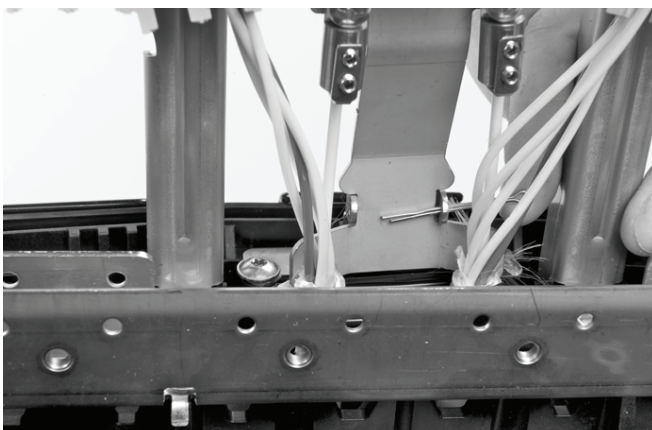

3.3.2 Install the 2 gel parts as described in 3.2.2 -3.2.3.

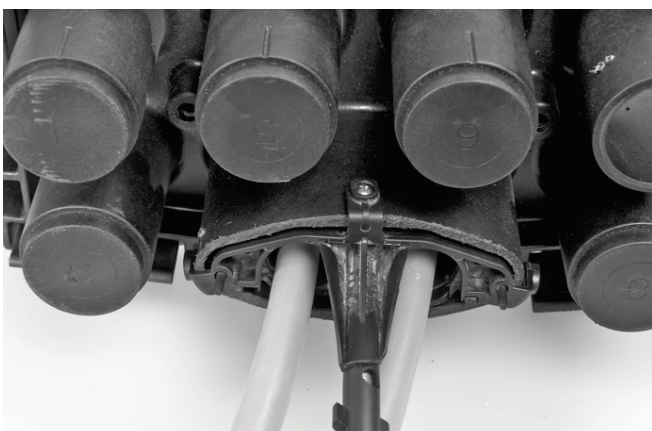

3.3.3 Insert the assembly as shown and secure with the split pin.

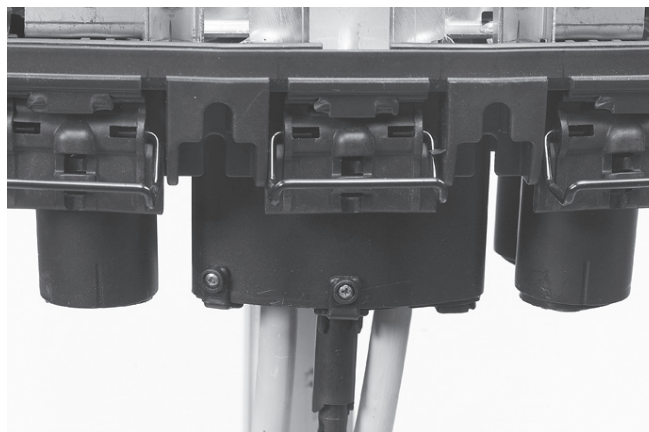

3.3.4 Tighten all 4 screws, make sure they grip in the port!

3.3.5 For loop storage and fiber termination see: II FIST-GCO2-F (TC 817/IP) § 4.1 c.

B Optional: FIST-GCO2-FX-EXT/CF

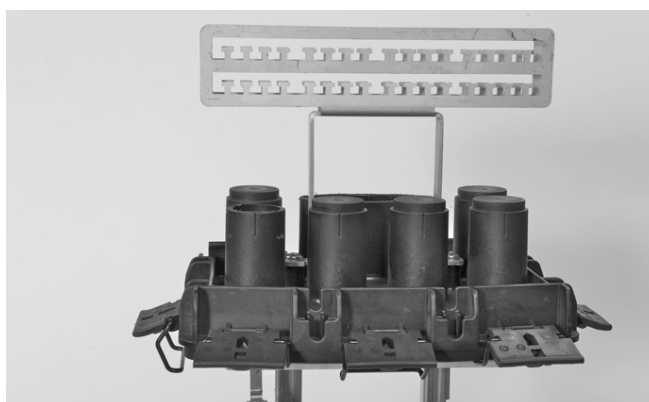
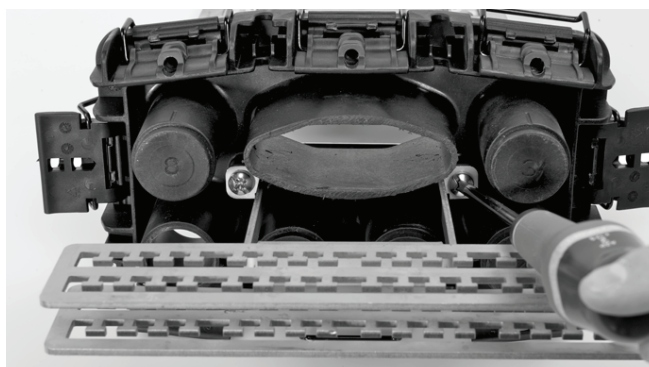

B1 Optional: the cable securing frame can be mounted on to the bottom of the closure with two delivered screws.

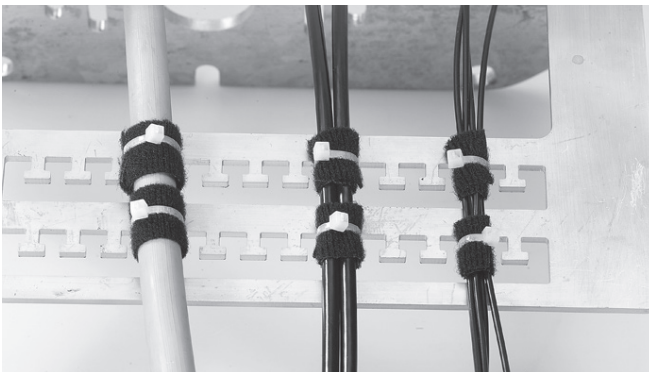

B2 Apply some foam to the cable(s) and secure with tie-wrap(s) to the frame.

3.4 Cable fixation in the FIST-GCO2-BX8

Remark: when uncut fibers will be stored, the window cut needs to be extended with 500 mm.

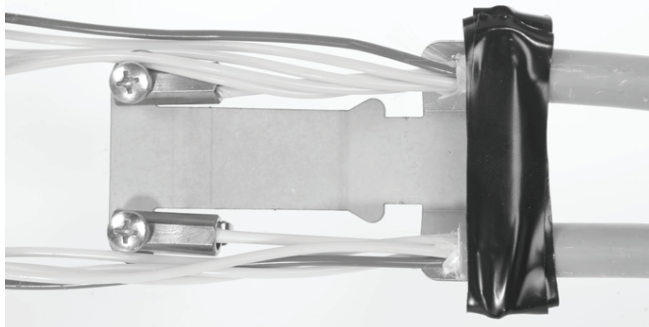
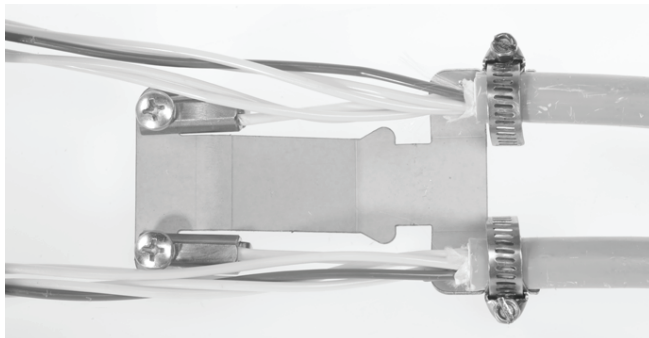

3.4.1 Install the metal bracket as shown: cables on top of metal bracket, hose clamps at the end of the cable jacket. Knobs between the cables. Apply some tape over the hose clamps. Strength members to be cut at 55 mm from the cable jacket.

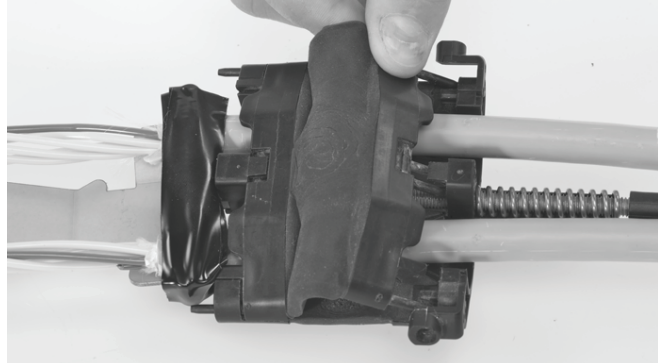
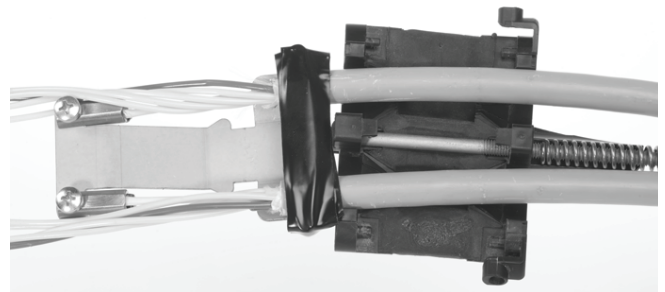

3.4.2 Take the first gel-part (with trigger) and put the 2 cables in place, if needed lubricate the cables. Take 2nd part and insert the pins in the corresponding holes at top and bottom.

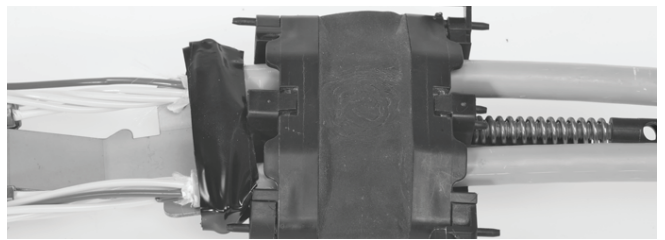

3.4.3 Securing hooks of part 2 must grip in part 1 (2 at top and 2 at bottom).

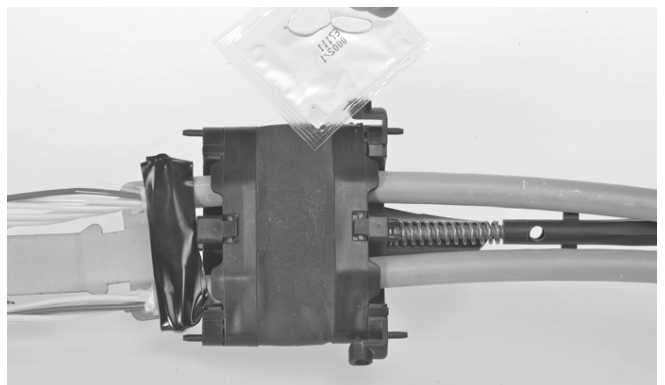

3.4.4 When needed apply some lubricant to the gel for ease of inserting.

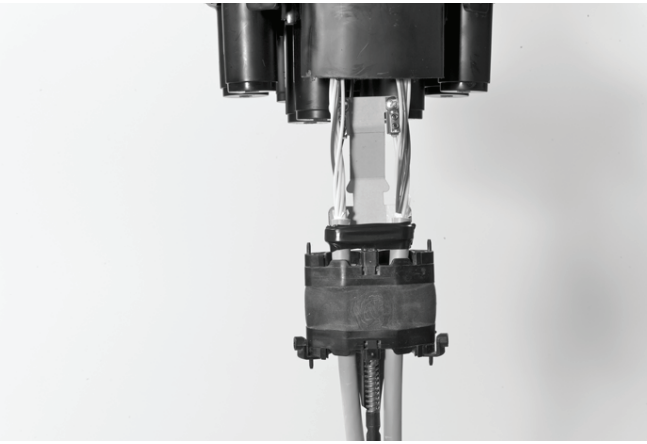

3.4.5 Insert the assembly as shown, metal bracket at the back of the cables!

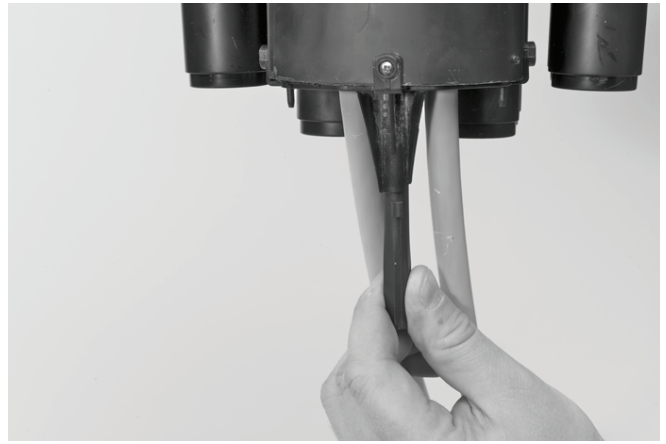

3.4.8 Tighten the trigger till it butts up with the flange.



3.4.6 Install the metal bracket to the frame and secure with split pin. Secure the strength members. Install the spiral tube over the loose tubes.

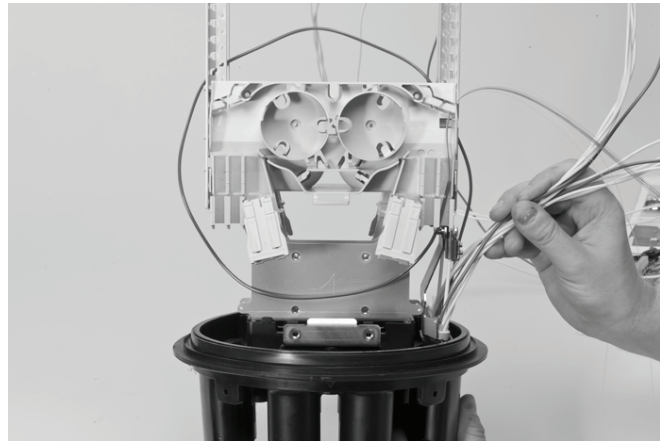

3.4.9 Tubes that will be shaved shall be routed between the UMS profiles (making a circle) and then routed via the bottom frame to the tube holder. Both sides can be reached. Shave between the 2 marks with the appropriate tooling. Add some PTFE tape to the end of the loose tube and fibers! Proceed as per standard practice.

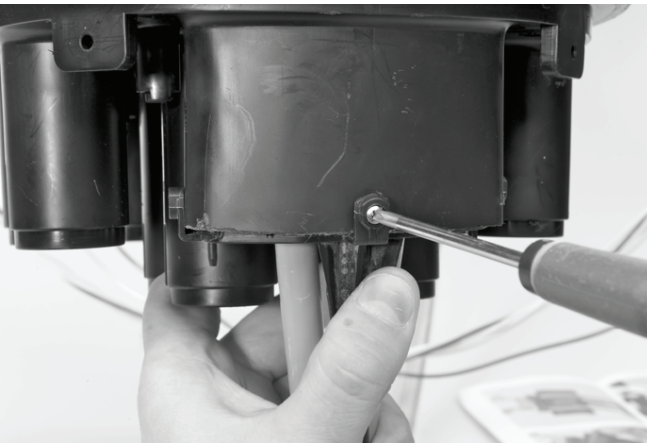

3.4.7 Tighten the 3 screws, make sure they grip in the port!

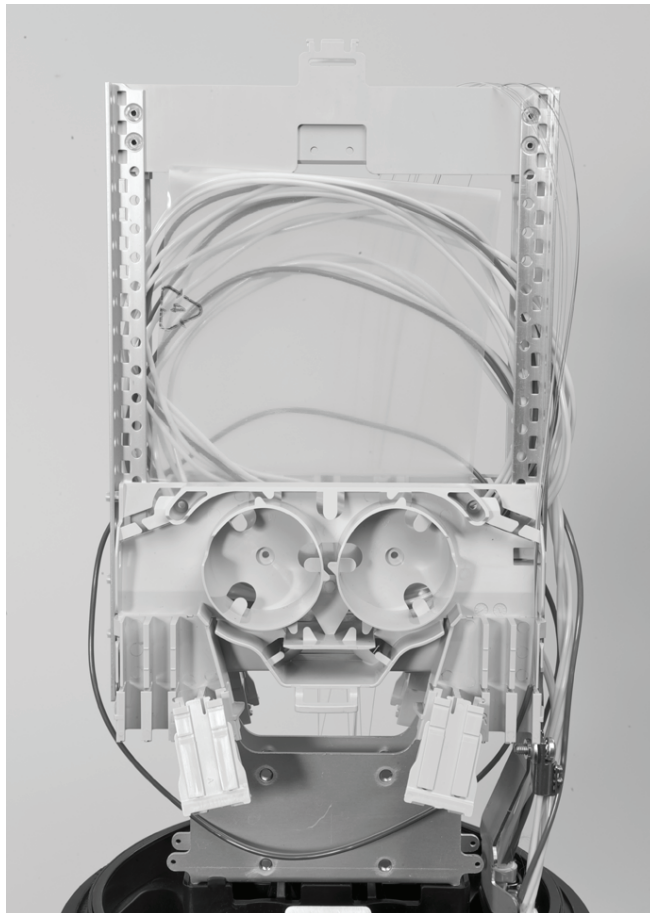

C Optional: FIST-GCO2-BX8

FIST-GCO2-BX8 cable securing frame

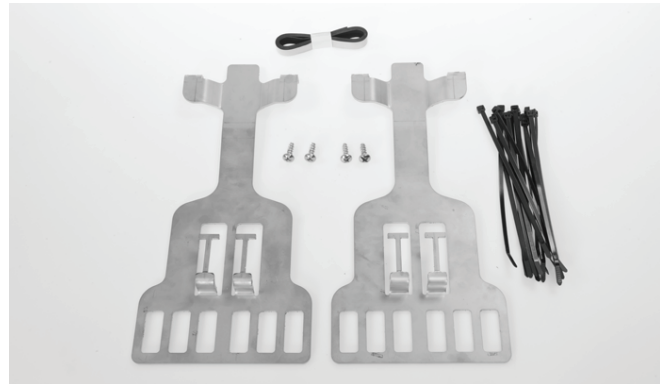

C1 A cable securing system can be mounted on to the base of the FIST-GCO2-BX8 with 4 screws. This allows cables to be secured outside the closure.



C2 Apply some foam to the cable(s) and secure with tie-wrap(s) to the frame.

3.2.10 Uncut or unshaved tubes shall be treated as standard practice (store in plastic bag between UMS profiles). Make sure that that the stored loops do not interfere with the shaved tubes.